

JVC

COLOUR VIDEO MONITOR

BEDIENUNGSANLEITUNG : FARB-VIDEO-MONITOR
MANUEL D'INSTRUCTIONS : MONITEUR VIDÉO COULEUR
ISTRUZIONI : MONITOR VIDEO A COLORI
MANUAL DE INSTRUCCIONES : MONITOR DE VIDEO A COLOR

TM-A140E

INSTRUCTIONS

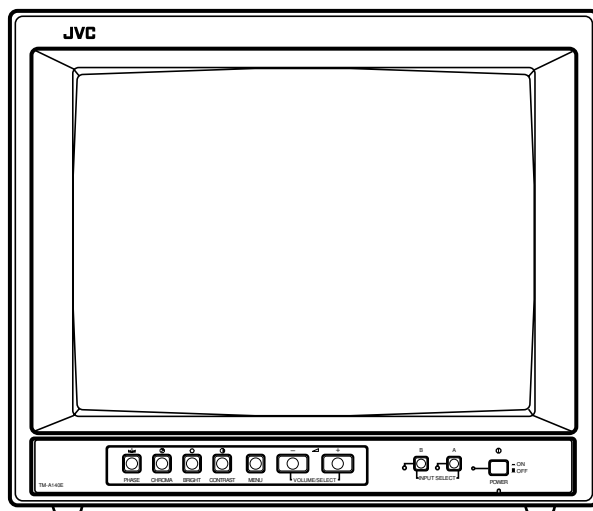

ENGLISH

DEUTSCH

FRANÇAIS

ITALIANO

ESPAÑOL

Thank you for purchasing this JVC colour video monitor. Before using it, read and follow all instructions carefully to take full advantage of the monitor's capabilities.

SAFETY PRECAUTIONS

In order to prevent any fatal accidents caused by misoperation or mishandling the monitor, be fully aware of all the following precautions.

WARNINGS

To prevent fire or shock hazard, do not expose this monitor to rain or moisture. Dangerous high voltages are present inside the unit. Do not remove the back cover of the cabinet. When servicing the monitor, contact qualified service personnel. Never try to service it yourself.

**WARNING : THIS APPARATUS
MUST BE EARTHED.**

Machine Noise Information Ordinance 3. GSGV, January 18, 1991: The sound pressure level at the operator position is equal or less than 70 dB (A) according to ISO 7779.

Improper operations, in particular alternation of high voltage or changing the type of tube may result in x-ray emission of considerable dose. A unit altered in such a way no longer meets the standards of certification, and must therefore no longer be operated.

PRECAUTIONS

- Use only the power source specified on the unit.
- When not using this unit for a long period of time, or when cleaning it, be sure to disconnect the power plug from the AC outlet.
- Do not allow anything to rest on the power cord. And do not place this unit where people will tread on the cord.
- Do not overload wall outlets or power cords as this can result in a fire or electric shock.
- Avoid using this unit under the following conditions:
 - in extremely hot, cold or humid places,
 - in dusty places,
 - near appliances generating strong magnetic fields,
 - in places subject to direct sunlight,
 - in badly ventilated places,
 - in automobiles with doors closed
- Do not cover the ventilation slots while in operation as this could obstruct the required ventilation flow.
- When dust accumulates on the screen surface, clean it with a soft cloth.
- Unplug this unit from the AC outlet and refer servicing to qualified service personnel under the following conditions:
 - when the power cord is frayed or the plug is damaged,
 - if liquid has been spilled into the unit,
 - if the unit has been dropped or the cabinet has been damaged,
 - when the unit exhibits a distinct change in performance.
- Do not attempt to service this unit yourself as opening or removing covers may expose you to dangerous voltage or other hazards. Always refer servicing to qualified service personnel.
- When replacement parts are required, have the service personnel verify in writing that the replacement parts he/she uses have the same safety characteristics as the original parts. Use of manufacture's specified replacement parts can prevent fire, shock, or other hazards.
- Upon completion of any servicing or repair work to this unit, please ask the service personnel to perform the safety check described in the manufacturer's service literature.
- When this unit reaches the end of its useful life, improper disposal could result in a picture tube implosion. Ask qualified service personnel to dispose of this unit.

SCREEN BURN

- It is not recommended to keep a certain still image displayed on screen for a long time as well as displaying extremely bright images on screen. This may cause a burning (sticking) phenomenon on the screen of cathode-ray tube. This problem does not occur as far as displaying normal video playback motion images.

POWER CONNECTION

WARNING

Do not cut off the main plug from this equipment.

If the plug fitted is not suitable for the power points in your home or the cable is too short to reach a power point, then obtain an appropriate safety approved extension lead or adapter or consult your dealer.

If nonetheless the mains plug is cut off, remove the fuse and dispose of the plug immediately, to avoid a possible shock hazard by inadvertent connection to the main supply.

If a new main plug has to be fitted, then follow the instruction given below:

WARNING:

THIS APPARATUS MUST BE EARTHED.

IMPORTANT

The wires in the mains lead on this product are coloured in accordance with the following cord:

- Green-and-yellow : Earth
- Blue : Neutral
- Brown : Live

As these colours may not correspond with the coloured making identifying the terminals in your plug, proceed as follows:

The wire which is coloured green-and-yellow must be connected to the terminal which is marked with the letter E or the safety earth symbol \oplus or coloured green or green-and-yellow.

The wire which is coloured blue must be connected to the terminal which is marked with the letter N or coloured black.

The wire which is coloured brown must be connected to the terminal which is marked with the letter L or coloured red.

When replacing the fuse, be sure to use only a correctly rated approved type, re-fit the fuse cover.

IF IN DOUBT — CONSULT A COMPETENT ELECTRICIAN.

How To Replace The Fuse

Open the fuse compartment with the blade screwdriver, and replace the fuse.

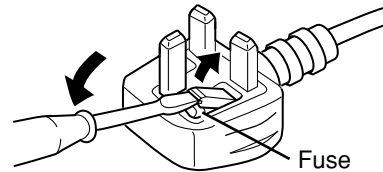

CONTENTS

SAFETY PRECAUTIONS.....	2
CONTROLS AND FEATURES.....	4
HOW TO HANDLE BASIC OPERATIONS	6
HOW TO USE THE MENU FUNCTIONS	7
HOW TO INITIALIZE THE SETTING	10
BASIC CONNECTION EXAMPLE	11
TROUBLESHOOTING	12
SPECIFICATIONS.....	13

**This manual is divided into five language sections:
English, German, French, Italian and Spanish.**

English	Page 2 to 15
German	Page 16 to 29
French.....	Page 30 to 43
Italian.....	Page 44 to 57
Spanish	Page 58 to 71

Dear Customer,

This apparatus is in conformance with the valid European directives and standards regarding electromagnetic compatibility and electrical safety.

European representative of Victor Company of Japan Limited is:





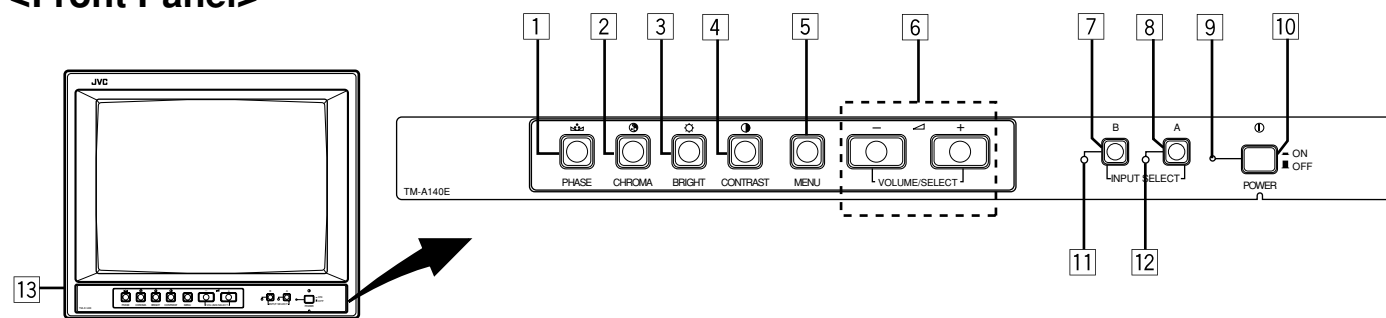

JVC Technology Centre Europe GmbH
Postfach 10 05 52
61145 Friedberg
Germany

CONTROLS AND FEATURES

FRONT VIEW

<Front Panel>



- 1 Phase button [PHASE **
Press this button to set the picture hue adjustment mode. Adjust the value with the VOLUME/SELECT buttons. Also used as a control button in the menu function mode.
- 2 Chroma button [CHROMA **
Press this button to set the picture colour density adjustment mode. Adjust the value with the VOLUME/SELECT buttons. Also used as a control button in the menu function mode.
- 3 Brightness button [BRIGHT **
Press this button to adjust picture brightness. Adjust the value with the VOLUME/SELECT buttons. Also used as a control button in the menu function mode.
- 4 Contrast button [CONTRAST **
Press this button to adjust picture contrast. Adjust the value with the VOLUME/SELECT buttons. Also used as a control button in the menu function mode.
- 5 Menu button [MENU]**
Displays and disappears the <MENU> screen.
Pressing the PHASE button with the Menu button depressed will display the <SET-UP MENU> screen.
- 6 Volume/Select buttons [VOLUME/SELECT -  +]**
Adjusts the speaker volume. Also used as a control button in the menu function mode.
- 7 Input B button [INPUT SELECT B]**
Selects the video signal input to the VIDEO B terminal and the audio signal input to the AUDIO B terminal (RCA connector) on the rear panel. When selected, the input B indicator **11** lights.
- 8 Input A button [INPUT SELECT A]**
Selects the video signal input to the VIDEO A terminal (BNC connector) and the audio signal input to the AUDIO A terminal (RCA connector) on the rear panel. When selected, the input A indicator **12** lights.
- 9 Power indicator**
Lights in green when the power is ON.
Lit : When the power is on.
Unlit : When the power is off.
- 10 Power switch [POWER **
Press this switch to turn the power on or off.
ON : Power is turned on.
OFF : Power is turned off.
- 11 Input B indicator**
Lights in green when the Input B is selected.
- 12 Input A indicator**
Lights in green when the Input A is selected.
- 13 Built-in speaker**
The speaker is located inside.

Note:

* The VIDEO B terminals include a video terminal (BNC connector) and a Y/C terminal (mini-DIN 4-pin connector). The Y/C (S-video) terminal is given priority.

REAR VIEW

<Rear Panel>

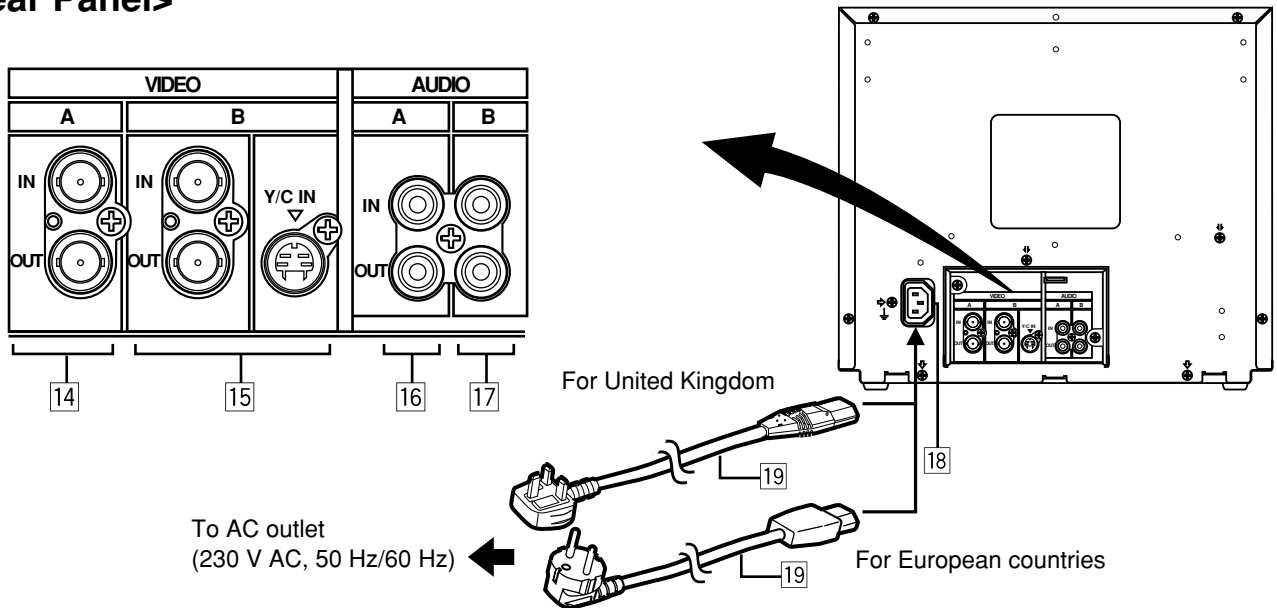

14 Video A terminals [VIDEO A IN/OUT]

Video signal input (IN) and output (OUT) terminals. The output terminal is bridge-connected.

IN : Video signal input terminal

OUT : Bridge-connected video signal output terminal

Notes:

- * For corresponding audio signals, use the AUDIO A terminals 16.
- * Also refer to the BASIC CONNECTION EXAMPLE on page 11.

15 Video B terminals [VIDEO B IN/OUT] [BNC connector]

Video signal input (IN) and output (OUT) terminals. The output terminal is bridge-connected.

IN : Video signal input terminal

OUT : Bridge-connected video signal output terminal

[Y/C connector]

Y/C (S-Video) signal input (mini-DIN 4-pin connector) terminal.

Y/C IN : Y/C signal input terminal.

Notes:

- * For corresponding audio signals, use the AUDIO B terminals 17.
- * There is no Y/C (S-video) signal output terminal.
- * When both VIDEO B terminals are connected (input) at the same time, the Y/C terminal is given priority.
- * Also refer to the BASIC CONNECTION EXAMPLE on page 11.

16 Audio A terminals [AUDIO A IN/OUT]

Input (IN) and output (OUT) terminals for the audio signals corresponding to the VIDEO A terminals 14. The output terminal is bridge-connected.

IN : Audio signal input terminal

OUT : Bridge-connected audio signal output terminal

Notes:

- * For corresponding video signals, use the VIDEO A terminals 14.
- * Also refer to the BASIC CONNECTION EXAMPLE on page 11.

17 Audio B terminals [AUDIO B IN/OUT]

Input (IN) and output (OUT) terminals for the audio signals corresponding to the VIDEO B terminals 15. The output terminal is bridge-connected.

IN : Audio signal input terminal

OUT : Bridge-connected audio signal output terminal

Notes:

- * For corresponding video signals, use the VIDEO B terminals 15.
- * Also refer to the BASIC CONNECTION EXAMPLE on page 11.

18 AC Inlet [AC IN]

Power input connector. Connect the provided AC power cord 19 to an AC outlet (230 V AC, 50 Hz/60 Hz).

19 Power cord

Connects the provided power cord (230 V AC, 50 Hz/60 Hz) to the AC IN connector.

HOW TO HANDLE BASIC OPERATIONS

BASIC OPERATION

1. Press the **POWER** switch to turn on the power.

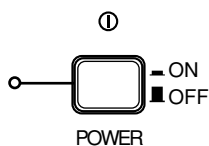

■ **ON** : Power turns ON. (Power indicator: lit)
 ■ **OFF** : Power turns OFF. (Power indicator: unlit)

2. Press the **INPUT SELECT** button to choose input.

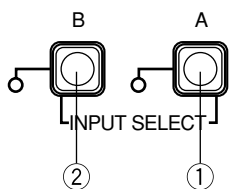

Selects video/audio signals input to terminals on the rear panel.

INPUT SELECT button	Terminals on the rear panel	
	Video signal input	Audio signal input
① Input A	VIDEO A terminal	AUDIO A terminal
② Input B	VIDEO B terminal	AUDIO B terminal

3. Press the **VOLUME/SELECT** buttons to adjust the speaker volume.

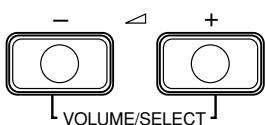

Press this button to display the speaker volume level on the screen.

+ : The Built-in speaker volume is increased. (00 → 50)
 - : The Built-in speaker volume is decreased. (50 → 00)
 * Screen indication will disappear about 10 seconds after operating.

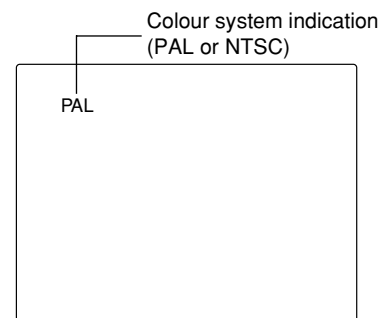

With regard to Colour system indication

● With the COLOR SYSTEM setting set to AUTO mode, when you turn on the power or select inputs, the colour system indication appears for about 3 seconds on the screen while PAL or NTSC signals are being detected. It does not appear when receiving B/W signal or when no signal is input. See page 7 for COLOR SYSTEM setting.

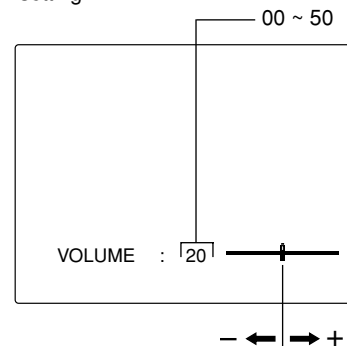

PICTURE ADJUSTMENT

1. Press select button corresponding to the item you want to adjust.

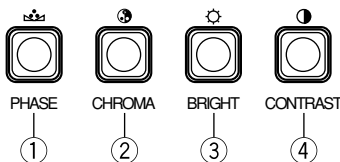

The item you select is displayed on the screen.

① PHASE (👑) : Phase control
 ② CHROMA (●) : Chroma control
 ③ BRIGHT (☀) : Brightness control
 ④ CONTRAST (●) : Contrast control

2. Adjust with the **VOLUME/SELECT** buttons.

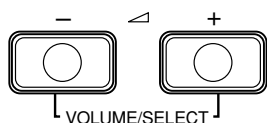

Items	VOLUME/SELECT button	
	-	+
PHASE (Phase)	reddish	greenish
CHROMA (Chroma)	lighter	deeper
BRIGHT (Brightness)	darker	brighter
CONTRAST (Contrast)	lower	higher

* Screen indication will disappear about 10 seconds after operating.

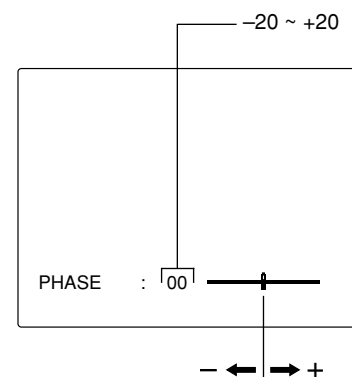

Notes:

- Phase control is effective only in the NTSC colour system mode.
- Chroma control is not effective when receiving B/W or when no signal is input.
- When the Chroma control is set to level "-20", the picture turns monochrome.
- "NO EFFECT" is displayed (For about 3 seconds) when your selected function has no effect.

HOW TO USE THE MENU FUNCTIONS

DISPLAY AND SELECTION IN THE <MENU> SCREEN MODE (SETTING)

You can set the following menu items.
Set them depending on your needs.

- SHARPNESS
- COLOR SYSTEM

1. Press the MENU button.



The <MENU> screen is displayed.

2. Press the PHASE () or CHROMA () button to select MENU items.

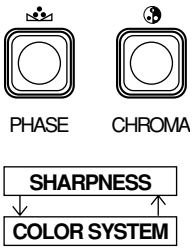

A selection mark (▶) is put next to the selected item.

Front panel button	Function displayed	Contents
PHASE ()	▼	Advance selection mark (▶).
CHROMA ()	▲	Reverse selection mark (◀).

3. Press the VOLUME/SELECT buttons to set.

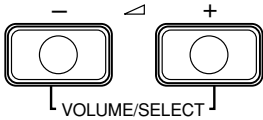

Front panel button	Function displayed	Contents
VOLUME/SELECT (+)	+	Increase (to max. value).
	▶	Advance the setting value.
VOLUME/SELECT (-)	-	Decrease (to min. value).
	◀	Reverse the setting value.

Menu items	Purpose	Setting range
SHARPNESS	Picture sharpness	00 ↔ +1 ↔ +2 ↔ +3 ↔ +4 ↔ +5
COLOR SYSTEM	Colour system	AUTO ↔ NTSC ↔ PAL ↑ ↓

* Normally set the COLOR SYSTEM to the AUTO mode. If reception in the AUTO mode is not good, set it to the exclusive mode (NTSC or PAL) corresponding to the received colour system.

4. If you want to set the other menu items, repeat procedures 2 and 3.

5. Press the MENU button to quit.



Front panel button	Function displayed	Contents
MENU	EXIT	Quit (or Release) the <MENU> screen.

<MENU> screen

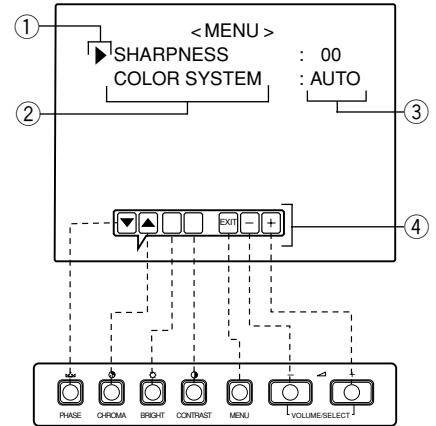

<Front panel button>

- Selection mark (▶):** Indicates the menu item you select.
- Menu item:** Menu items you can select.
- Setting display:** Indicates the current settings (value).
- Function display:** The functions of the front panel buttons (7 buttons on the left) correspond to the function displayed.

Function displayed	Contents
▼	Advance the menu item.
▲	Reverse the menu item.
-	Lower the adjustment value (to the minimum).
+	Raise the adjustment value (to the maximum).
▶	Advance the setting value.
◀	Reverse the setting value.
EXIT	Exits the <MENU> screen.

HOW TO USE THE MENU FUNCTIONS (cont'd)

DISPLAY AND SELECTIONS IN THE <SET-UP MENU> MODE (SETTING)

You can set the following set-up menu items.

- H. POSITION
- WHITE BALANCE
- CONTROL LOCK

Note:

- Parameters for H. POSITION can be set separately depending on the video input (Input A or Input B) selected by the input select buttons on the front panel. Select the required video input with the input select buttons on the front panel in advance.

1. While pressing the MENU button, press the PHASE () button.

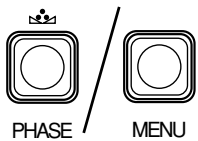

The <SET-UP MENU> screen is displayed.

<SET-UP MENU> screen

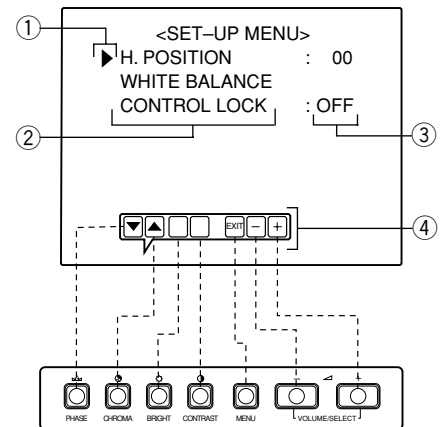



<Front panel button>

- ① **Selection mark (▶):** Indicates the menu item you select.
- ② **Menu item:** Menu items you can select.
- ③ **Setting display:** Indicates the current settings (value).
- ④ **Function display:** The functions of the front panel buttons (7 buttons on the left) correspond to the function displayed.

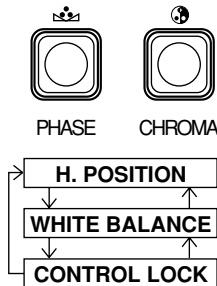
2. Press the PHASE () or CHROMA () button to select the desired menu item.



A selection mark (▶) is put next to the selected item.

Front panel button	Function displayed	Contents
PHASE ()	▼	Advance selection mark (▶).
CHROMA ()	▲	Reverse selection mark (◀).

Function displayed	Contents
▼	Advance the menu item.
▲	Reverse the menu item.
-	Lower the adjustment value (to the minimum).
+	Raise the adjustment value (to the maximum).
▶	Advance the setting value.
◀	Reverse the setting value.
EXIT	Exit the <SET-UP MENU> screen (release).
DRV	Selects DRV adjustment.
CUTO	Selects CUT OFF adjustment.
R	Adjusts red signal level.
G	Adjusts green signal level.
B	Adjusts blue signal level.
DISP	Turns the ON-SCREEN display on or off. (This function is effective only in the DRIVE or CUT OFF adjustment mode.)

3. Press the VOLUME/SELECT buttons to set.

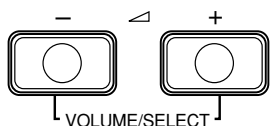

Front panel button	Function displayed	Contents
VOLUME/SELECT (+)	+	Increase (to max. value).
	▶	Advance the setting value.
	CUTO	Selects CUT OFF setting screen.
VOLUME/SELECT (-)	-	Decrease (to min. value).
	◀	Reverse the setting value.
	DRV	Selects DRIVE setting screen.

Notes:

- For the WHITE BALANCE setting, select the CUT OFF or DRIVE setting screen, then select the buttons (PHASE/CHROMA/BRIGHT) corresponding to the function indicated (R/G/B).
- To return to the <SET-UP MENU> screen, press the EXIT (MENU) button.

Set-up menu items	Purpose	Settings
H. POSITION	Adjusts the horizontal position of the screen (+ : Horizontal position shifts to the right/-: Horizontal position shifts to the left).	-05 ↔ -04 ←···→ -01↔00 ↔ +01 ←···→ +04 ↔ +05
WHITE BALANCE	Adjusts the white balance.	Selects DRIVE (DRV) or CUT OFF (CUTO) adjustment. Screen setting is changed to the selected setting mode. Select R/G/B buttons corresponding to the function display to adjust.
DRIVE R.DRIVE	Adjusts red level.	-09 ↔ -08 ←·····→ -01↔00 ↔ +01 ←·····→ +08 ↔ +09
B.DRIVE	Adjusts blue level.	-09 ↔ -08 ←·····→ -01↔00 ↔ +01 ←·····→ +08 ↔ +09
CUT OFF R. CUT OFF	Adjusts red cut off.	-09 ↔ -08 ←·····→ -01↔00 ↔ +01 ←·····→ +08 ↔ +09
G. CUT OFF	Adjusts green cut off.	-09 ↔ -08 ←·····→ -01↔00 ↔ +01 ←·····→ +08 ↔ +09
B. CUT OFF	Adjusts blue cut off.	-09 ↔ -08 ←·····→ -01↔00 ↔ +01 ←·····→ +08 ↔ +09
CONTROL LOCK	Sets the operation buttons on the front panel to control lock mode.	OFF ↔ ON

4. To set the other set-up menu items, repeat the procedures 2 and 3.

5. Press the MENU button to quit.



Front panel button	Function displayed	Contents
MENU	EXIT	Quit (or Release) the <MENU> screen.

Notes:

- When the CONTROL LOCK function is set to ON, pressing operation buttons on the front panel will display the message "CONTROL LOCK ON!" on the screen for about 3 seconds.
- The CONTROL LOCK function is maintained even when the power is turned off.
- To turn off the CONTROL LOCK function, while holding the MENU button press the PHASE button. Then set the CONTROL LOCK function to OFF.
- Even when the CONTROL LOCK function is set to ON, the following operations are available:
 - Power Switch operation.
 - Sound volume adjustment with the VOLUME/SELECT buttons.
 - Display or disappear of the <SET-UP MENU> screen.

HOW TO INITIALIZE THE SETTING

SCREEN DISPLAY AND SELECTIONS IN THE <SET-UP MENU> RESET MODE

You can set <MENU> and <SET-UP MENU> screen items, picture adjustment items and the volume level to their factory-set (initial) values.

1. Press the POWER (ⓘ) switch to turn the power OFF (■).

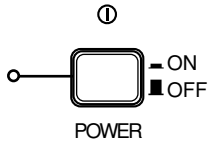

2. While pressing both MENU button and PHASE (👤) button, press the POWER (ⓘ) switch to turn the power ON (■).

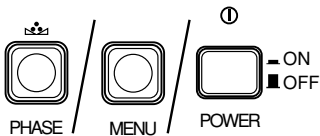

The <SET-UP MENU> RESET screen is displayed.

Note:

- The <SET-UP MENU> RESET screen will not be displayed if the MENU or PHASE buttons are pressed for a very short time. Keep pressing them until the display screen appears.

3. Press the CONTRAST (◐) button.



Initialization starts.

* The <SET-UP MENU> RESET screen disappears automatically after finishing initialization.

Note:

- **To cancel initialization.**
Press the VOLUME/SELECT [+] or [-] buttons.
* The <SET-UP MENU> RESET screen disappears after cancelling initialization.

<SET-UP MENU> RESET screen

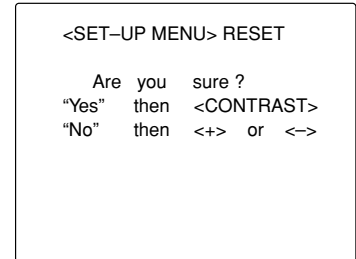

Initial settings

Sorts	Functions (Items)	Initialization (setting)
<MENU> screen	SHARPNESS	00
	COLOR SYSTEM	AUTO
<SET-UP MENU> screen	H. POSITION	00
	WHITE BALANCE	
	R. CUT OFF	00
	G. CUT OFF	00
	B. CUT OFF	00
	R. DRIVE	00
	B. DRIVE	00
CONTROL LOCK	OFF	
Picture adjustment	PHASE	00
	CHROMA	00
	CONTRAST	00
	BRIGHT	00
Volume	VOLUME	20

BASIC CONNECTION EXAMPLE

Notes:

- Before connecting your system, make sure that all units are turned off.
- The illustration below shows some examples of different connections. Terminal connections may differ depending on the component connected. Be sure to refer to the instructions provided with the unit(s) you are connecting.
- Each pair of input (IN) and output (OUT) terminals are bridge-connected. However, the Y/C input terminal (Y/C IN) has no output terminal (OUT) corresponding to it.
- If you're not connecting any equipment to a bridged output (OUT) terminal, be sure not to connect any other cables to the bridged output (OUT) terminal as this will cause the terminating resistance switch to open (auto terminate function).
- When making a bridge connection, connect the input (IN) and output (OUT) terminals on the monitor to separate video components.
(For example, if both terminals are connected to the same VCR, resonance may occur except during playback. This is caused by the same video signal "looping" between the VCRs, and is not a malfunction.)
- Select the video input (Input A or Input B) with the input select button on the front panel.

VIDEO A Connection Example (Select Input A button)

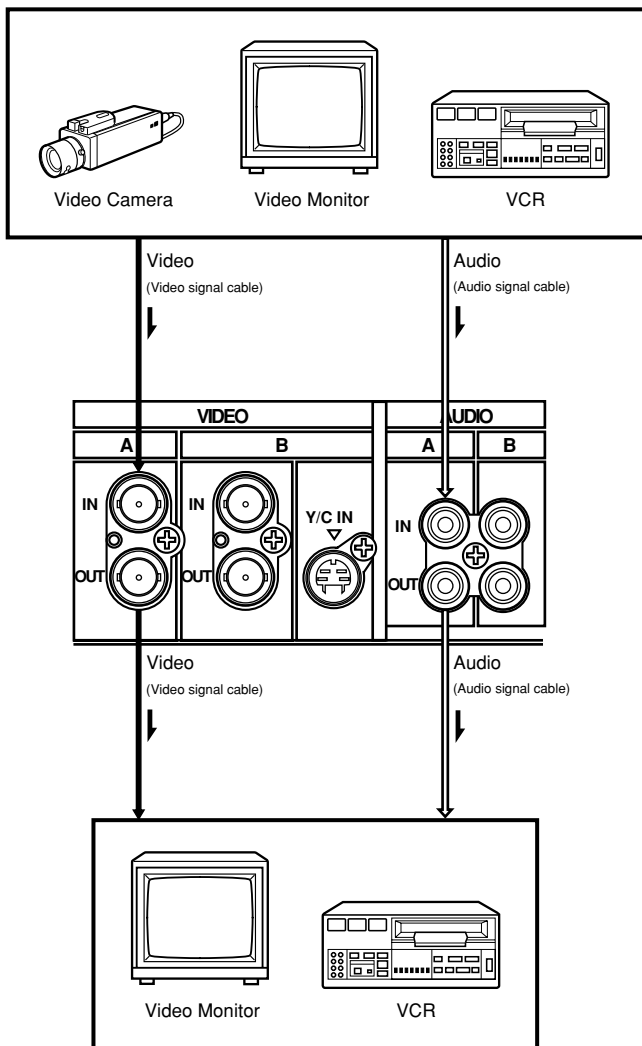

VIDEO B Connection Example (Select Input B button)

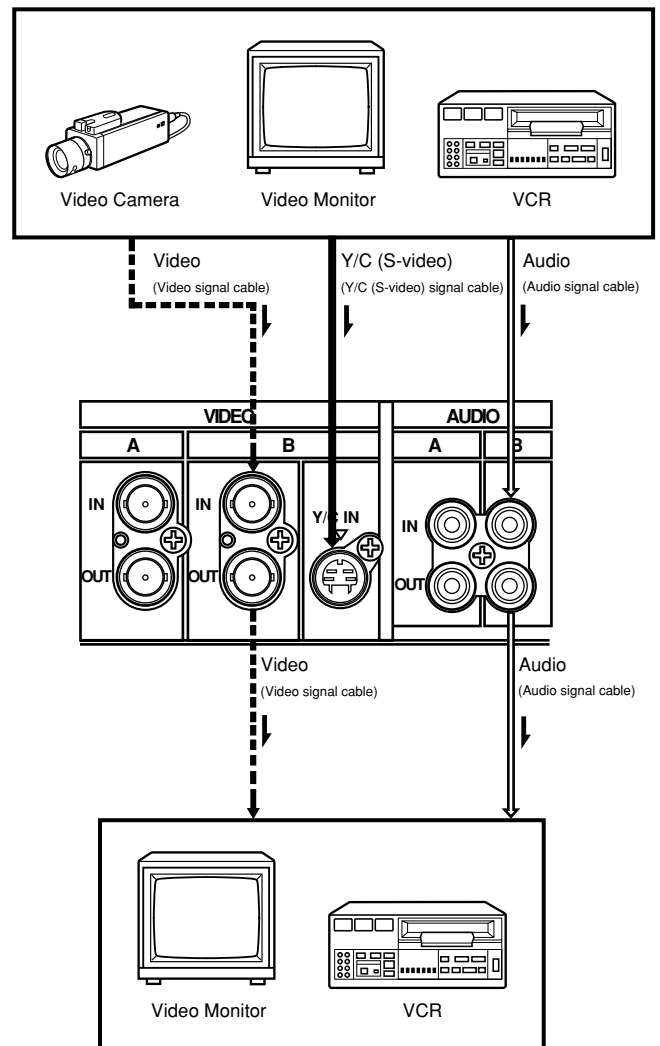

↓ : Signal Flow

↓ : Signal Flow

TROUBLESHOOTING

Solutions to common problems related to your monitor are described here. If none of the solutions presented here solves the problem, unplug the monitor and consult a JVC-authorized dealer or service center for assistance.

Problems	Points to be checked	Measures (Remedy)
No power supply.	Is the power plug loosened or disconnected?	Firmly insert the power plug.
No picture with the power on.	Is the video signal output from the connected component?	Set the connected component correctly.
	Is the input signal selected properly?	Select the required video signal input with the Input select button. (See page 6.)
	Is the video cable disconnected?	Connect the video signal cable firmly. (See page 11.)
No sound.	Is the audio signal output from the connected component?	Set the connected component correctly.
	Is the volume output set to minimum?	Adjust the speaker volume with the VOLUME/SELECT buttons. (See page 6.)
	Is the audio cable disconnected?	Connect the audio signal cable firmly. (See page 11.)
Shaking picture.	Is the monitor close to a device generating a strong magnetic field?	Move the device away from the monitor until the picture stabilizes.
No colours, wrong colour, or dark picture.	Is the colour system selected properly?	Set the COLOR SYSTEM in the <MENU> screen mode to [AUTO] mode. (See page 7.)
	Has the picture control setting (CONTRAST, BRIGHT, CHROMA or PHASE) been changed?	Set each picture control to the standard setting. (See page 6.)
Unnatural, irregularly coloured, or distorted picture.	Is the monitor close to a speaker, magnet or any other device generating a strong magnetic field?	Move the device away from the monitor and turn the monitor's power off. Wait at least 30 minutes, then turn the power on again.
Front panel button does not function.	Are the operation buttons on the front panel locked? (Has CONTROL LOCK function set to ON?)	Set the CONTROL LOCK to OFF in the <SET-UP MENU> screen mode. (See pages 8 and 9.)

The following are not malfunctions:

- When a bright still image (such as a white cloth) is displayed for a long period, it may appear to be coloured. This is due to the structure of the cathode ray tube and will be deleted when another image is displayed.
- You experience a mild electric shock when you touch the picture tube. This phenomenon is due to a normal buildup of static electricity on the CRT and is not harmful.
- The monitor emits a strange sound when the room temperature changes suddenly. This is only a problem if an abnormality appears on the screen as well.
- If two or more monitors are operated next to each other, their images may shake or be distorted. This phenomenon is due to mutual interference; it is not a malfunction.
Move the monitors away from each other until the interference disappears or turn the power off on any monitor that is not being used.

SPECIFICATIONS

MODEL		TM-A140E
Type		Colour video monitor
Colour system		PAL, NTSC (3.58)
Picture tube		36 cm measured diagonally, 90° deflection, in-line gun, vertical line trio type (phosphor stripe pitch 0.64 mm)
Effective screen size		Width 280.8 mm Height 210.6 mm Diagonal 335.4 mm
Scanning frequency		H : 15.734 kHz (NTSC), 15.625 kHz (PAL) V : 59.94 Hz (NTSC), 50 Hz (PAL)
Horizontal resolution		320 TV lines or more (Y/C input mode)
Input terminals	VIDEO A	Composite video: 1 line, BNC connector x 2, 1 Vp-p, 75 Ω negative sync (bridge connection possible, auto termination)
	VIDEO B	Composite video: 1 line, BNC connector x 2, 1 Vp-p, 75 Ω negative sync (bridge connection possible, auto termination)
		Y/C-separated: 1 line, mini-DIN 4-pin connector x 1 Y: 1.0 Vp-p, 75 Ω C: 0.286 Vp-p, 75 Ω (NTSC), 0.3 Vp-p, 75 Ω (PAL)
	AUDIO A	1 line (monaural), RCA pin x 2, 0.5 V rms, high-impedance (bridge connection possible)
	AUDIO B	1 line (monaural), RCA pin x 2, 0.5 V rms, high-impedance (bridge connection possible)
Audio power output		1 W (monaural)
Built-in speaker		8 cm round x 1, impedance of 8 Ω
Environmental conditions		Operation temperature: 0 °C – 40 °C Operation humidity: 20% – 80% (non-condensing)
Power requirements		230 V AC, 50 Hz/ 60 Hz
Power consumption		0.55 A (230 V AC)
Dimensions		Width 346 mm Height 310 mm Depth 368.5 mm
Weight		12.2 kg
Accessory		AC power cord (2 m) x 1 (for United Kingdom) AC power cord (2 m) x 1 (for European countries)

* Illustrations used in this manual are for explanatory purposes only. The appearance of the actual product may differ slightly.

* Dimensions and weight are approximate.

* E. & O. E. Design and specifications subject to change without notice.

■ Dimensions

Unit : mm

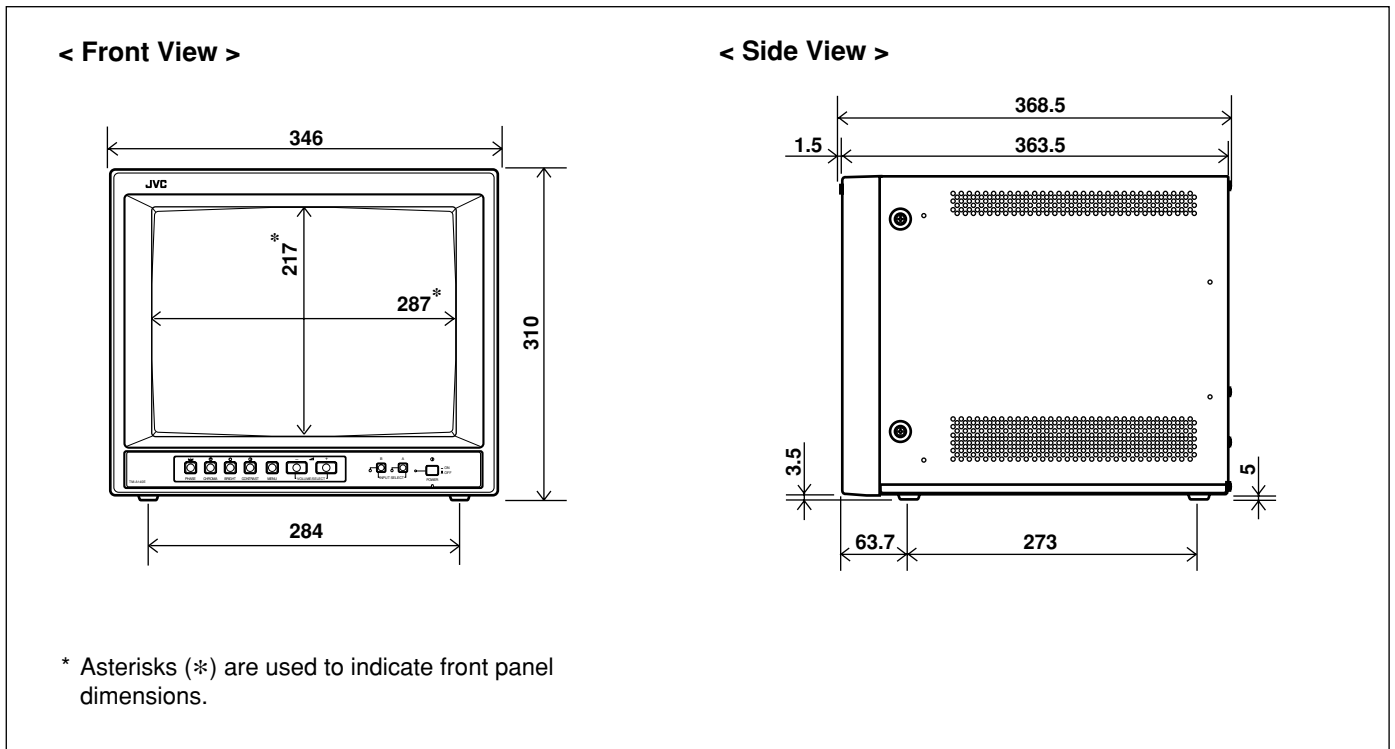

■ Y/C (Mini DIN 4 pin) terminal specification

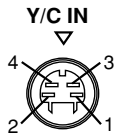

Pin No.	Signal
1	GND (Y)
2	GND (C)
3	Y
4	C

